

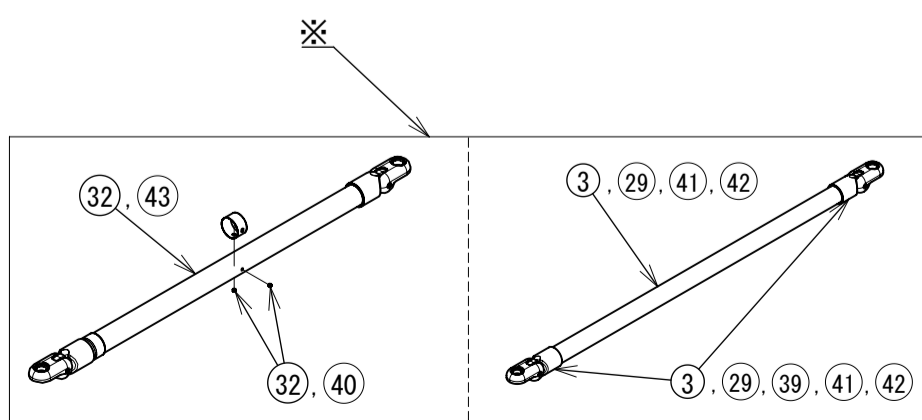

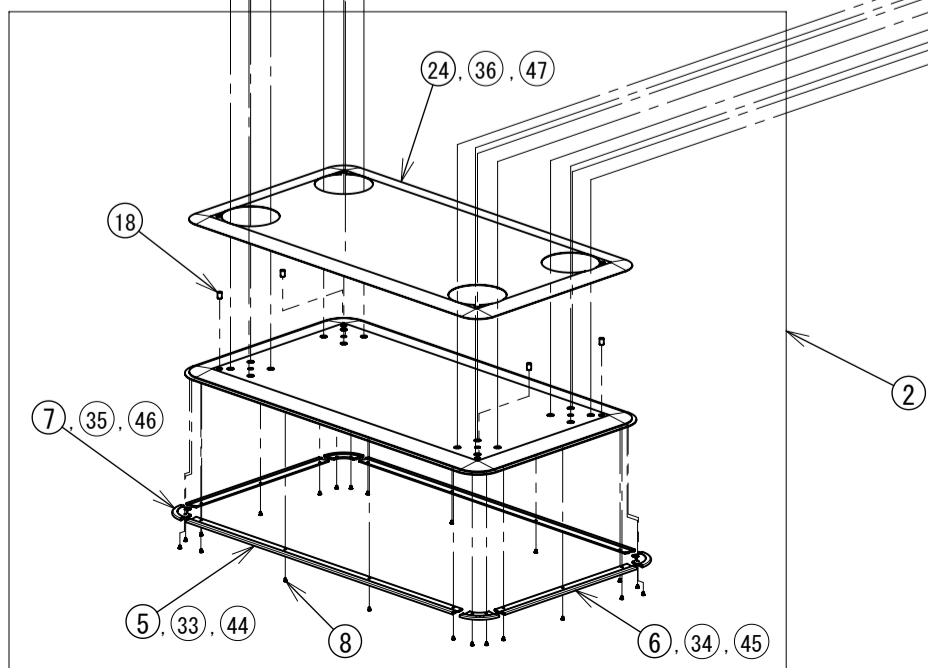

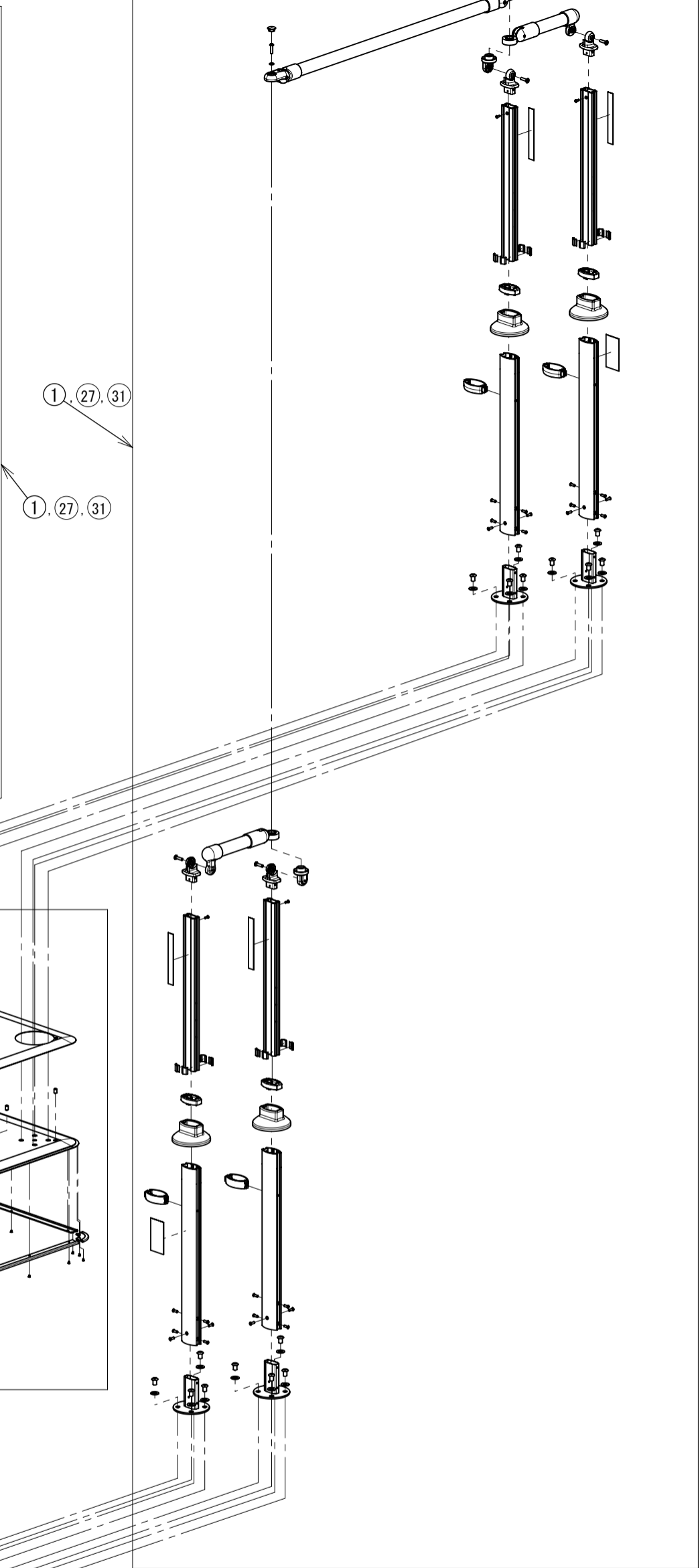

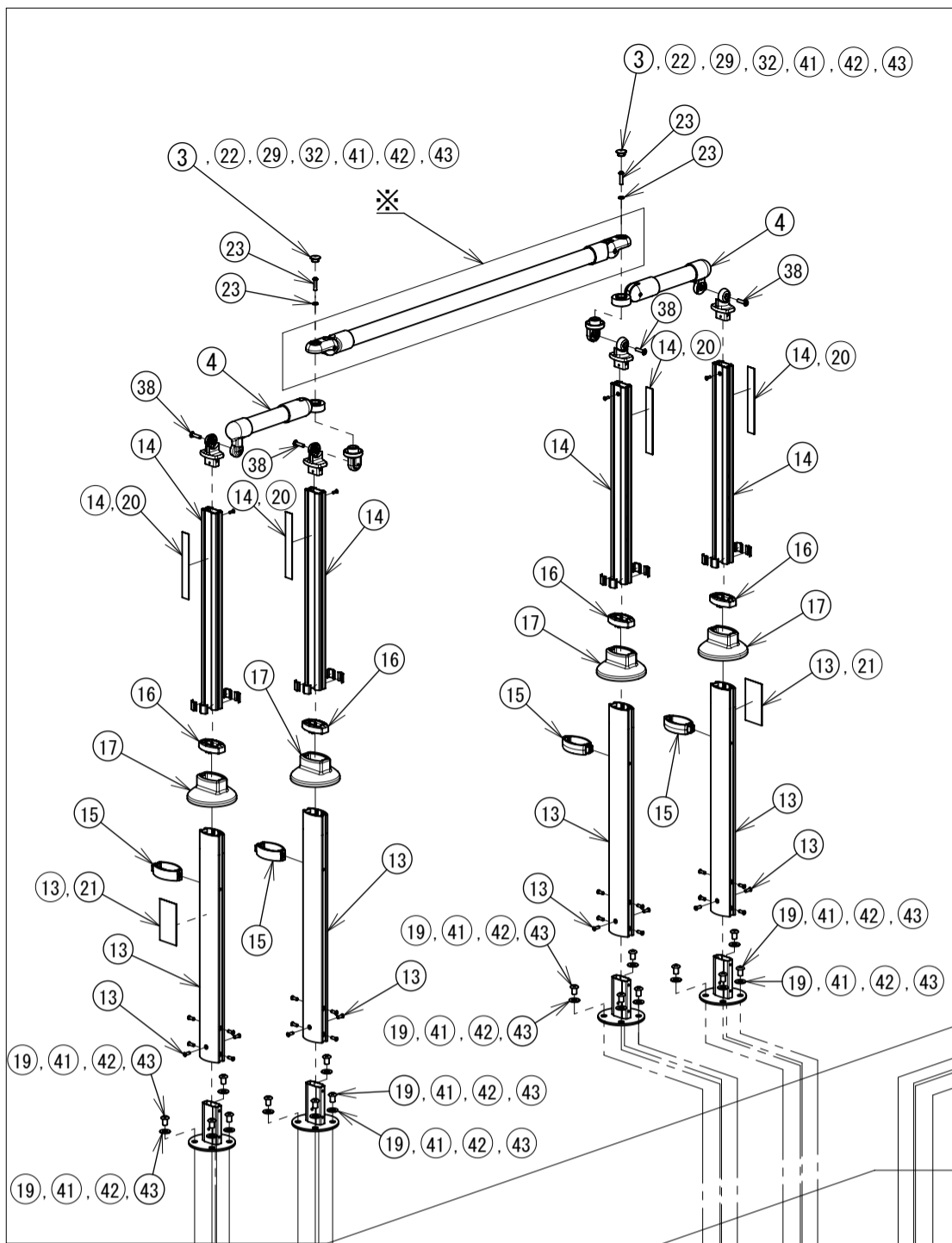



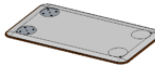





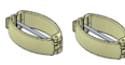
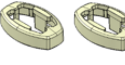

AT-C-930/630/E1050

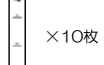

AT-C-930T/630T/E1050T

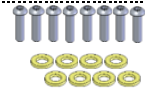
NO.	内容物	部品名	部品コード	税抜価格(円)	部品販売 対応表									
					930	930T	630	630T	240	240T	E1050	E1050T	E1050-S	E1050T-S
①		AT-C-930〈手すり支柱セット〉 ※製品と同じ梱包状態	592221	98,000	○	○	—	—	—	—	—	—	—	—
②		AT-C共通A-フレームプレート ※製品と同じ梱包状態	592220	85,000	○	○	○	○	○	○	○	○	○	○
③		AT-C-930手すり支柱(キャップ付)	592222	17,800	○	○	—	—	—	—	—	—	—	—
④		AT-C用240手すり支柱	592223	9,500	○	○	○	○	—	—	○	○	○	○
⑤		AT-C用端面保護カバー70cm(4本)	592224	4,000	○	○	○	○	○	○	○	○	○	○
⑥		AT-C用端面保護カバー35cm(4本)	592225	3,100	○	○	○	○	○	○	○	○	○	○
⑦		AT-C用端面保護カバーコーナー(4個)	592226	2,900	○	○	○	○	○	○	○	○	○	○
⑧		AT-C用端面保護カバーホト(22個)	592227	2,300	○	○	○	○	○	○	○	○	○	○
⑬		AT-C用外支柱(ねじ付)(2本)	592232	7,500	○	○	○	○	△ 別途 警告シール 必要	△ 別途 警告シール 必要	○	○	△ 別途 警告シール 必要	△ 別途 警告シール 必要
⑭		AT-C用スライド支柱(シール付)(2本)	592233	7,500	○	○	○	○	○	○	○	○	○	○
⑮		AT-C用高さ調節固定リング(2個)	592234	3,800	○	○	○	○	○	○	○	○	○	○
⑯		AT-C用支柱キャップ(2個)	592235	2,300	○	○	○	○	○	○	○	○	○	○
⑰		AT-C用支柱レベルカバー(2個)	592236	2,500	○	○	○	○	○	○	○	○	○	○
⑱		AT-C用高さ調整用ホルム(4個)	592237	2,200	○	○	○	○	○	○	○	○	○	○
⑲		AT-C用支柱固定ホルム(8個) ※ワッシャー8枚付き	592238	3,400	○	○	○	○	○	○	○	○	○	○
⑳		AT-C用高さ目盛りシール(10枚)	592241	2,800	○	○	○	○	○	○	○	○	○	○
㉑		AT-C用警告シール(10枚)	592242	3,000	○	○	○	○	—	—	○	○	—	—
㉒		AT-C用可変支柱ラケットキャップ(8個)	592243	2,400	○	○	○	○	—	—	○	○	○	○
㉓		AT-C用回転固定ホルム(8本) ※ワッシャー8枚付き	592244	2,700	○	○	○	○	—	—	○	○	○	○
㉔		AT-C用滑り止めシートKA(大)(2枚)	592248	11,000	○	○	○	○	○	○	○	○	○	○
㉕		AT-C用滑り止めシートKA(小丸)(8枚)	592249	3,400	○	—	○	—	○	—	○	—	○	—

